

**1. UNIVERSAL RIDGE CAP**

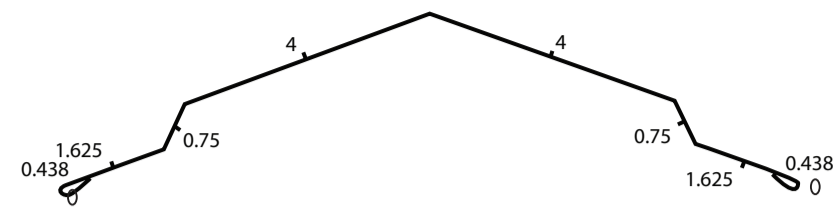

**2. RAKE & CORNER**

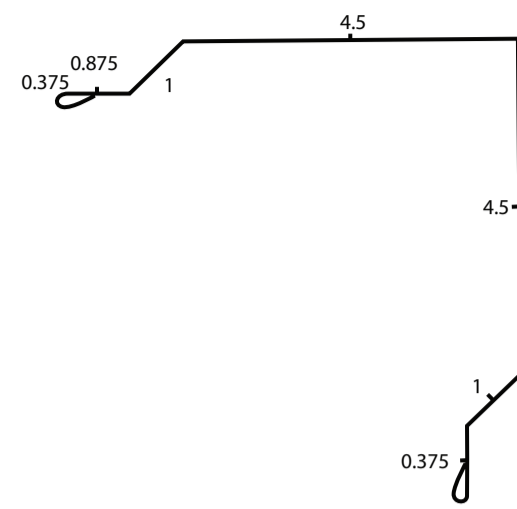

**3. MINI CORNER**

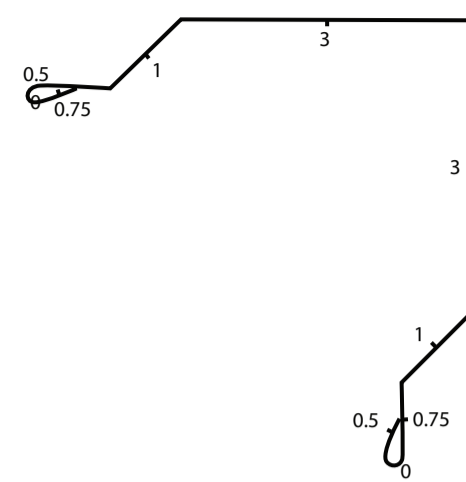

**4. SNOW RAIL**

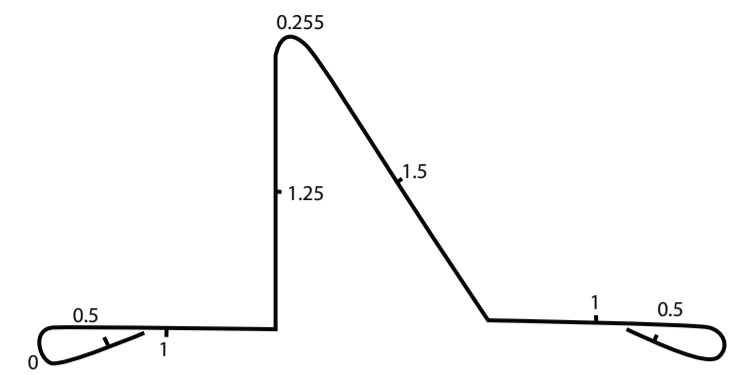

**5. 13" I/S CORNER**

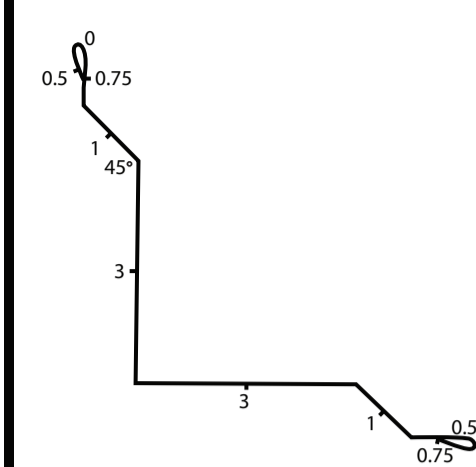

**6. RESIDENTIAL RAKE**

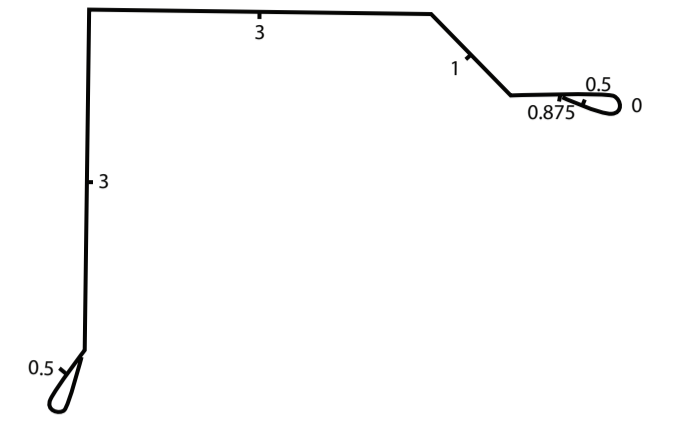

**7. DRIP EDGE**

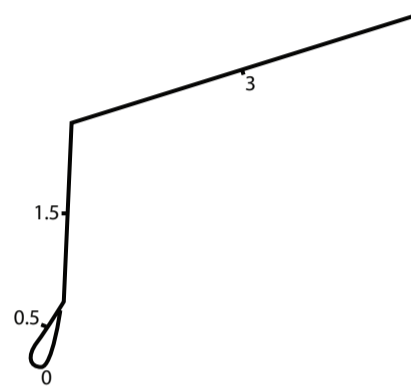

**8. SPLASH GUARD**

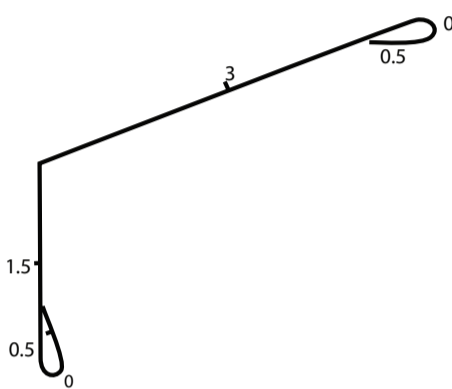

**9. BASE ANGLE**

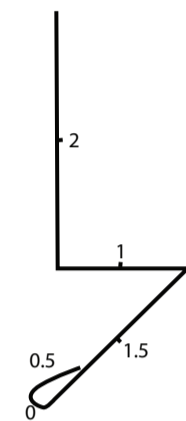

**10. DOUBLE ANGLE**

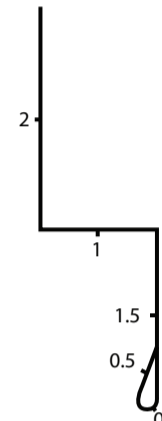

**11. DRIP CAP**

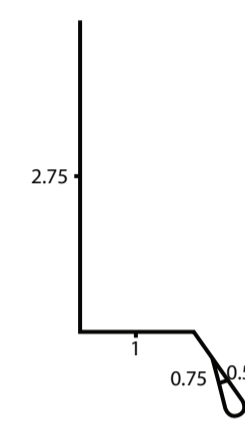

**12. 1.5" X 1.5" ANGLE**

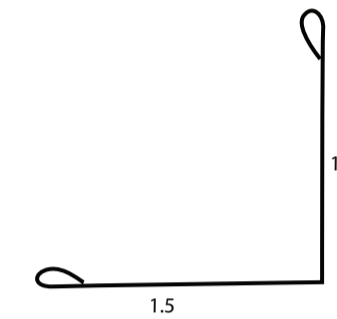

**13. OVERHEAD DOOR TRIM**

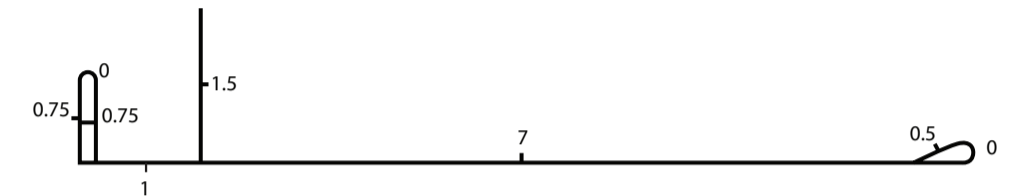

**14. 2" X 2" ANGLE**

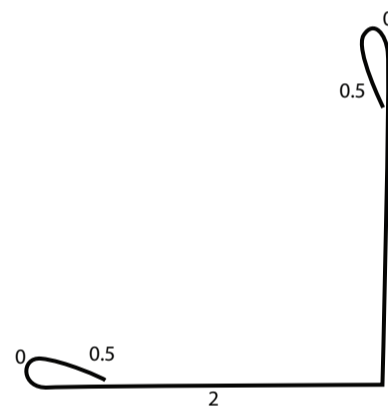

**15. FASCIA**

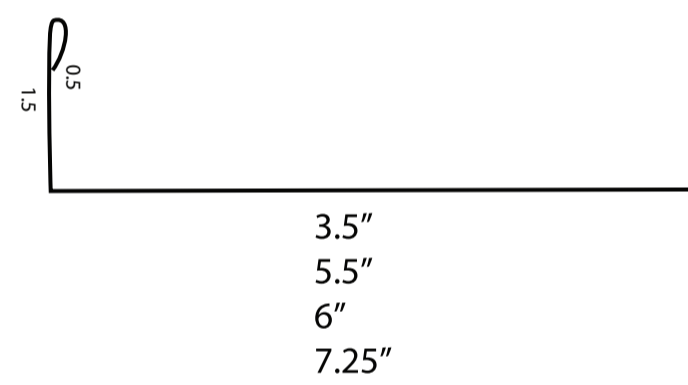

**16. 3" X 3" ANGLE**

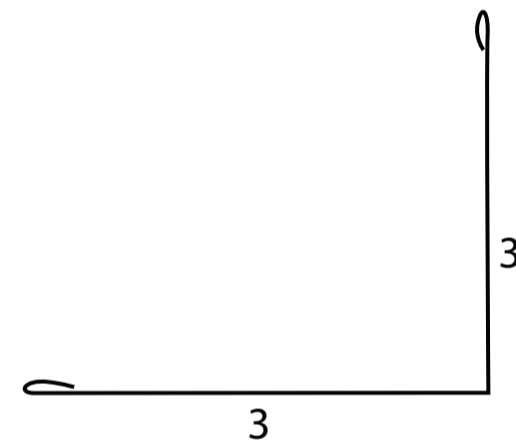

**17. FASCIA**

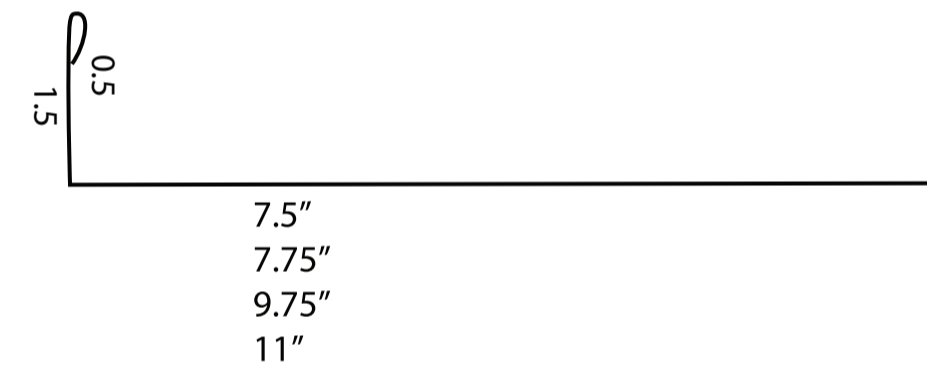

**18. J CHANNEL**

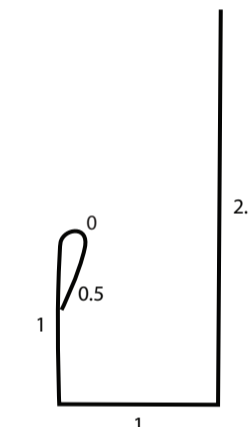

**19. F&J CHANNEL**

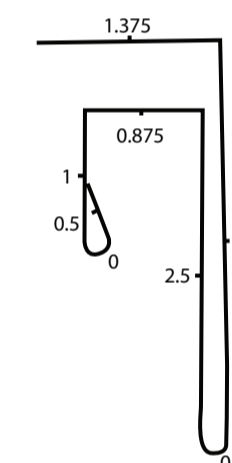

**20. C&T CHANNEL**

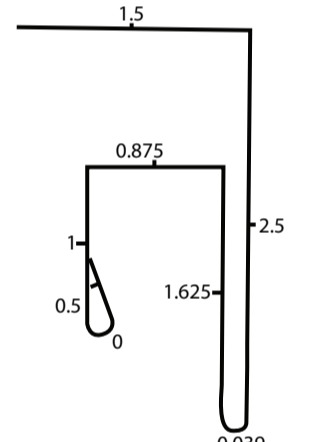

**21. DENVER EAVE**

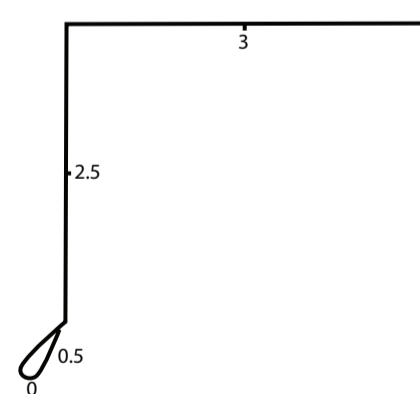

**22. ENDWALL FLASHING**

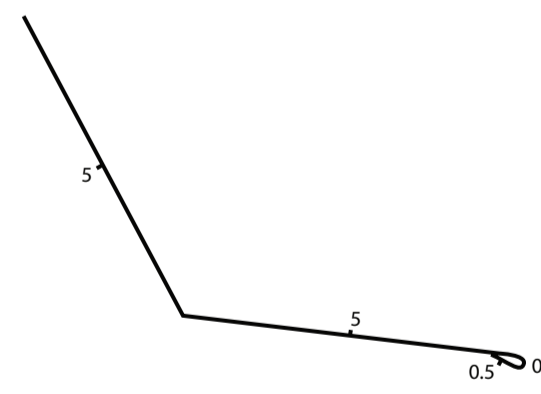

**23. TRANSITION FLASHING**



**24. SIDEWALL FLASHING**

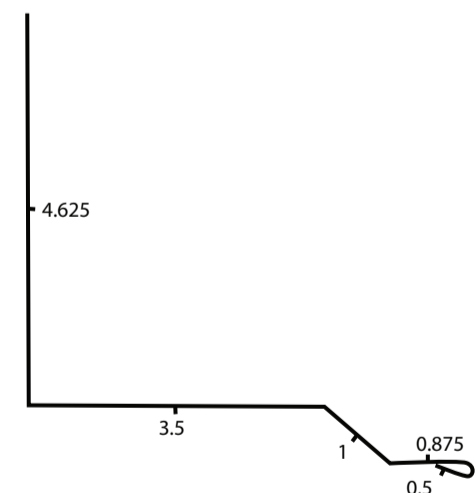

**25. HIP COVER**

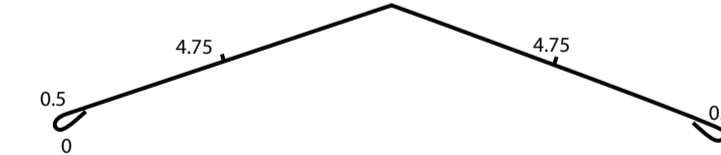

**26. GAMBREL TRIM**

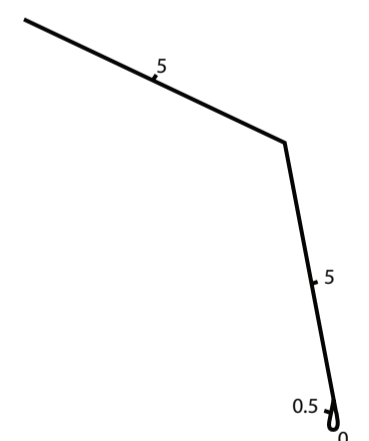

**27. VALLEY**

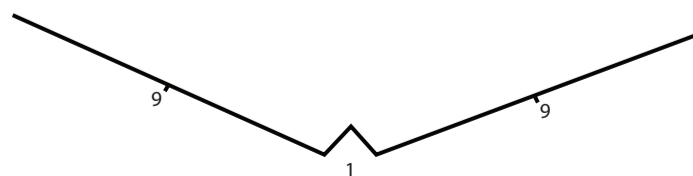

**28. INTERIOR BASE**

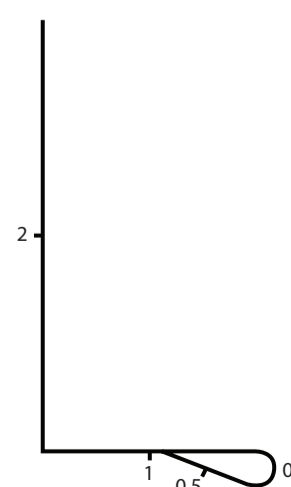

**29. TRACK COVER**

